

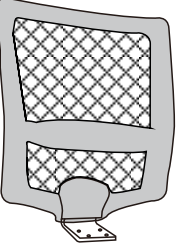







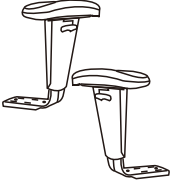

MODEL: B699

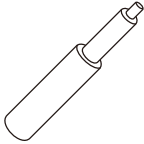
<p>(A)x1</p>  <p>Back Cushion</p>	<p>(B)x1</p>  <p>Seat Cushion</p>	<p>(C)x2</p>  <p>Left-Arm Right-Arm</p>
<p>(D)x5</p>  <p>Caster</p>	<p>(E)x1</p>  <p>Gas Lift W/ Cover</p>	<p>(F)x1</p>  <p>Base</p>
<p>(H)x1</p>  <p>Mechanism</p>	<p>(G)x8  M6x35 Arm Screw</p> <p>(G1)x4  M8x30 Mechanism Screw</p> <p>(G2)x4  M8x35 L-bar Screw</p> <p>(L)x1  Allen Key</p>	

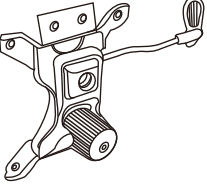

Insert and loosely tighten all screws. When assembly is completed, fully tighten all screws before using. This chair is only intended for sitting. Any other use will void the warranty.

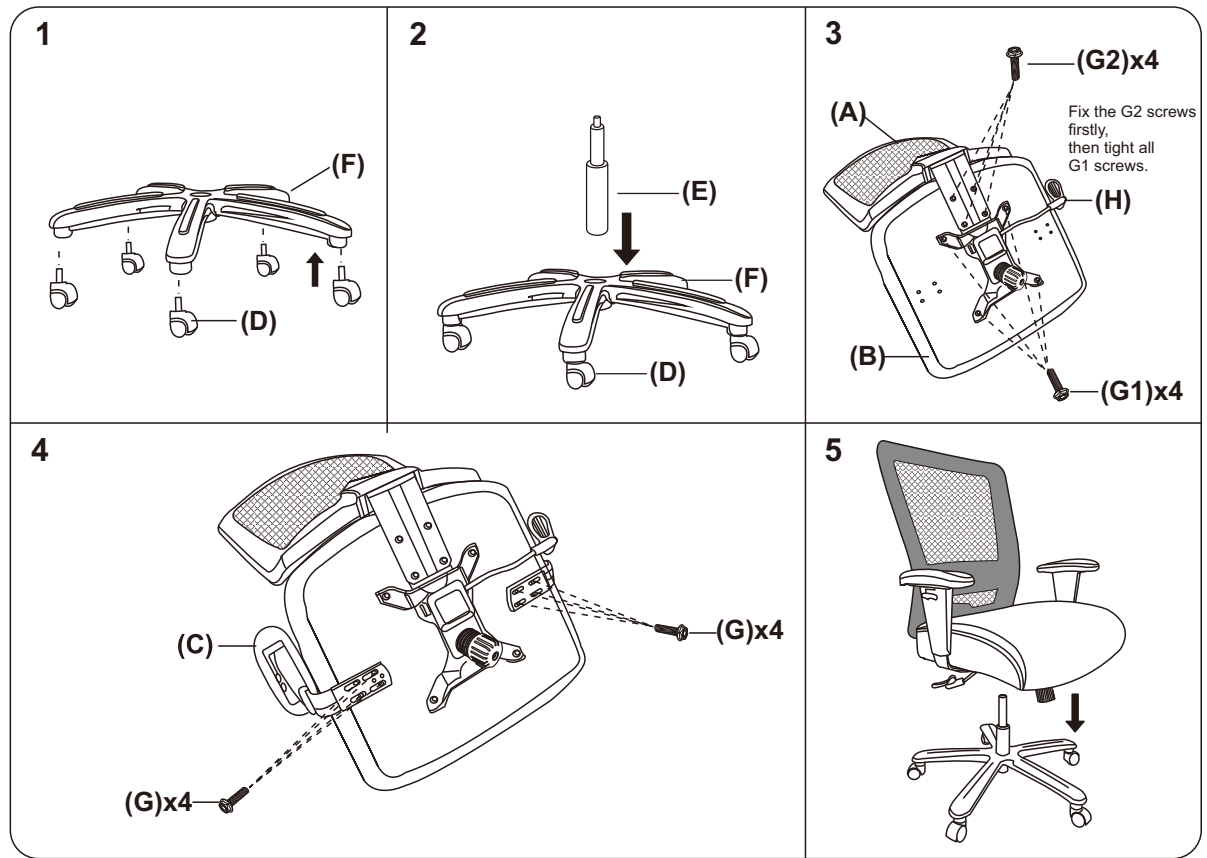