







MODEL: 16240

(1)x1	(2)x5	(3)x1
		
Seat Cushion & mechanism	TU015 / Casters	TU005-240/5 / Base
(4)x1	(5)x1	(6)x1
		
TU026-240/5- Gas Lift	TU009	TU009-EXT

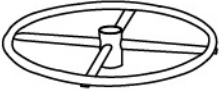

Insert and loosely tighten all screws. When assembly is completed, fully tighten all screws before using. This chair is only intended for sitting. Any other use will void the warranty.

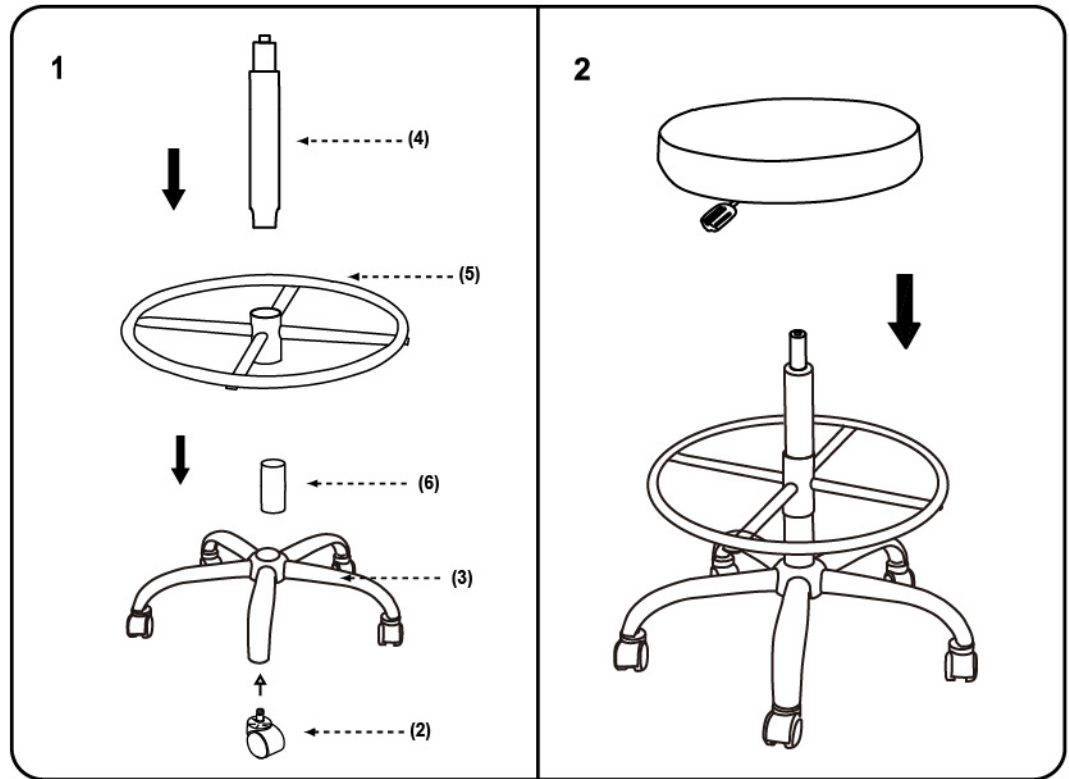