







**IMPORTANT NOTICE:
HARDWARE PACKAGE IS ATTACHED
ON THE BOTTOM OF SEAT CUSHION.**

MODEL: B3035 3036 3037 B3045 3046 3047

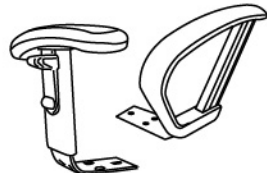
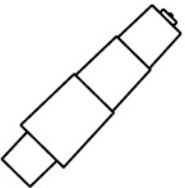
(1)x1  Back Cushion	(2)x1  Seat Cushion	(3)x1 (L)x1 (R)  Left-Arm-L Right-Arm-R
(4)x1  Gas Lift W/ Cover	(5)x1  Base	(6)x 5  Caster
(A)x6  M6 X 28 Arm Screws		

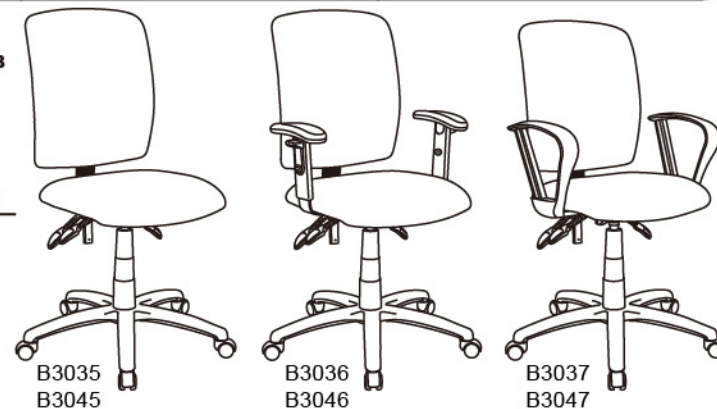
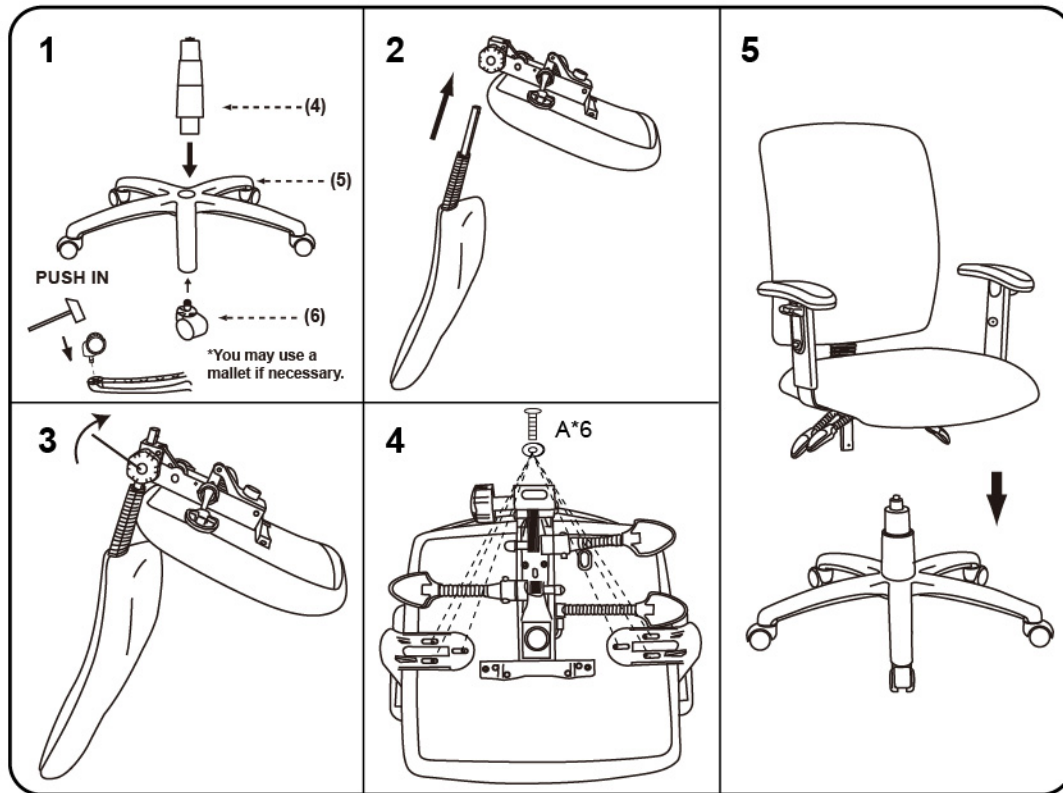

Insert and loosely tighten all screws. When assembly is completed, fully tighten all screws before using. This chair is only intended for sitting. Any other use will void the warranty.