







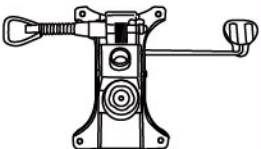

**IMPORTANT NOTICE:  
HARDWARE PACKAGE IS ATTACHED  
ON THE BOTTOM OF SEAT CUSHION.**

MODEL : B6776

(1)x1	(2)x1	(3)x1 (L)x1 (R)
		
Back	Seat	Right & Left Arm
(4)x1	(5)x1	(6)x1
		
Mechanism	Gas Lift	Base
(7)x5		
	(A)*4  <b>M8*22</b> Mechanism Screw	(B)*8  <b>M6*22</b> Arm Screw
Casters	(C)*8  Arm Cap	

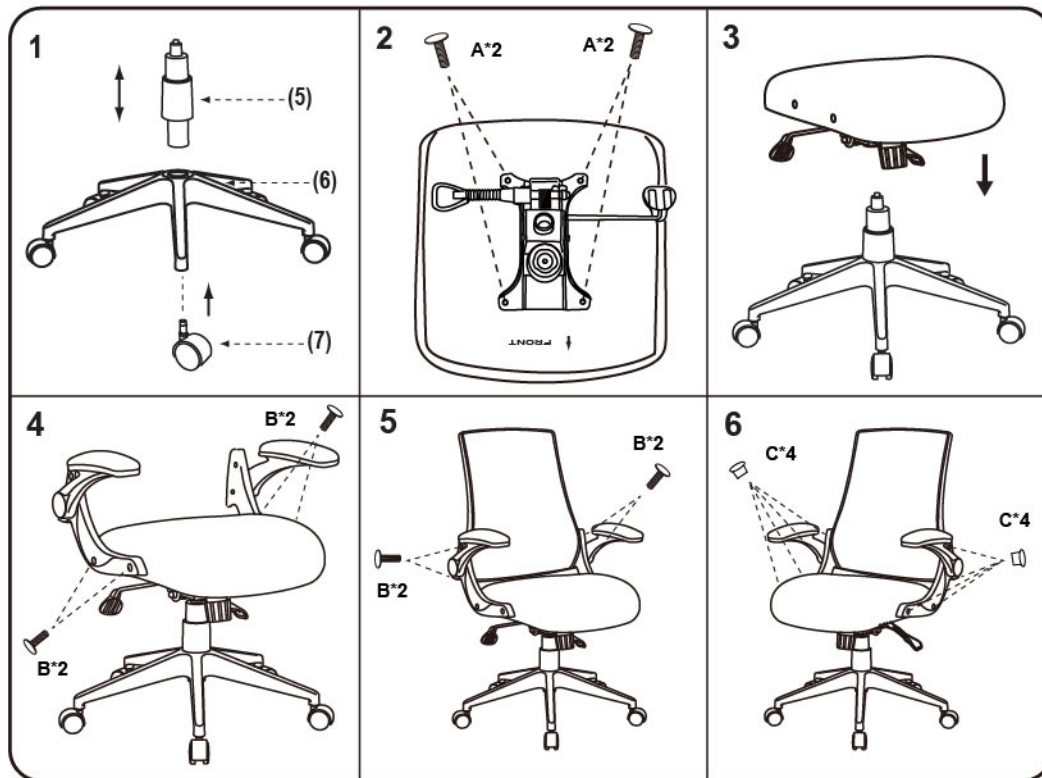

**Insert and loosely tighten all screws.  
When assembly is completed, fully tighten  
all screws before using. This chair is only  
intended for sitting. Any other use will  
void the warranty.**

