

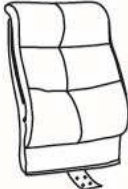

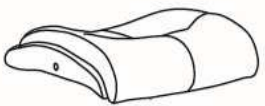

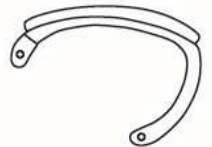

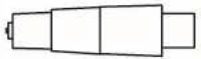

**IMPORTANT NOTICE:
HARDWARE PACKAGE IS ATTACHED
ON THE BOTTOM OF SEAT CUSHION.**

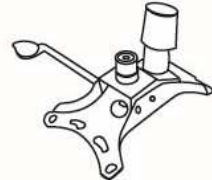
MODEL : B8771/B8776

(1)x1  Back Cushion	(2)x1  Seat Cushion	(3)x1 (L)x1 (R)  Left & Right-Arm
(4)x1  Gas Lift W/ Cover	(5)x1  Base	(6)x1  Mechanism
(7)x5  Caster	(A)x4  M8*22 MECHANISM SCREW	(B)x4  M8*45 ARM SCREW
	(C)x4  M8*30 L-BAR SCREW	(D)x4  ARM CAPS
	(E)x1  ALLEN KEY	

Insert and loosely tighten all screws. When assembly is completed, fully tighten all screws before using. This chair is only intended for sitting. Any other use will void the warranty.

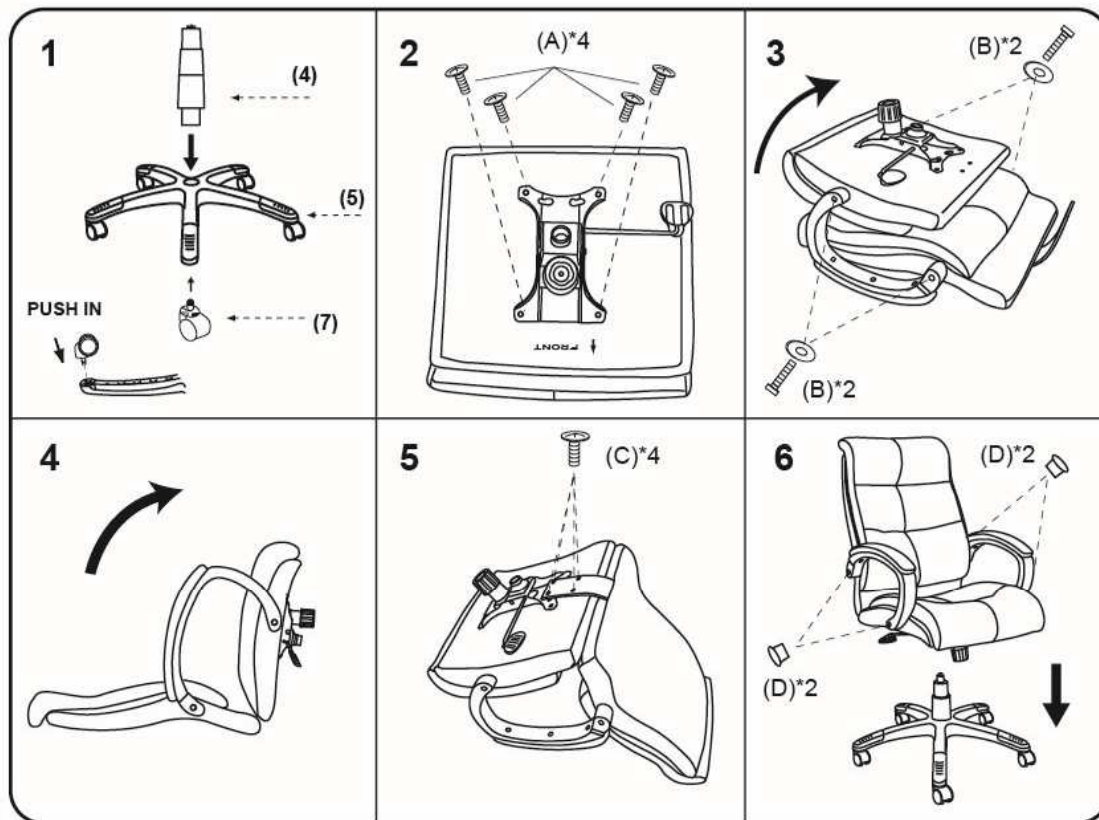

Note: Please tighten all arm screws using allen key before step 6

