







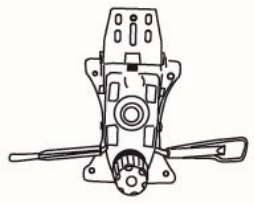

MODEL : B8886AL-AM

(1)x1  Back Cushion	(2)x1  Seat Cushion	(3)x1 (L)x1 (R)  Left- Arm Right- Arm
(4)x1  Mechanism	(5)x1  Gas Lift	(6)x1  Base
(7)x5  Caster		
(A)x4  M8*22 MECHANISM SCREW	(B)x2  M6*25 ARM SCREW	(C)x4  M6*30 ARM SCREW
(D)x3  M8*18 L-BAR SCREW		

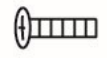

Insert and loosely tighten all screws. When assembly is completed, fully tighten all screws before using. This chair is only intended for sitting. Any other use will void the warranty.

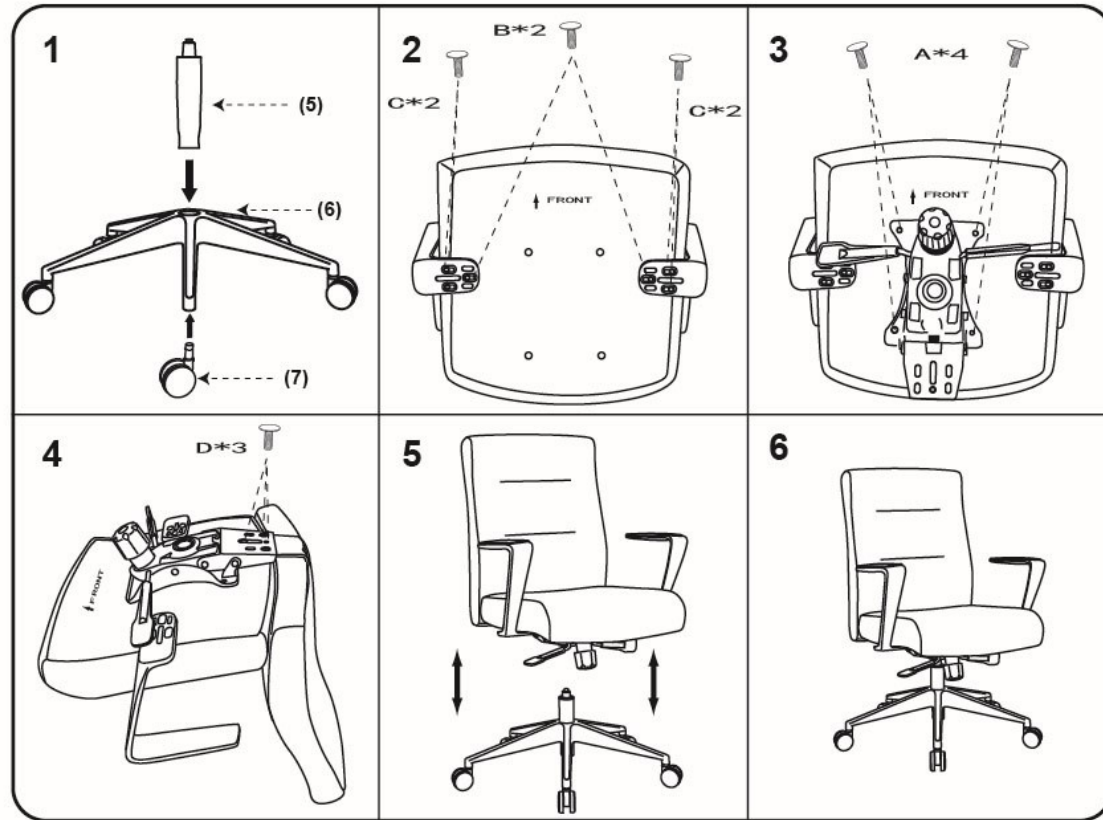