







Assembly Instructions
MODEL NO.:N111
 CREDENZA SHELL

TUN01OCL	TUN011KC	TUN011KC	TUN026	TUN021AG	TUN018SC	TUN013LB	TUN015BG
 Cam lock 12pcs+1pc(spare)	 Klix Cam 12pcs+1pc(spare)	 Cam Cover 17pcs+1pc (spare)	 Dowel 10Pcs+1Pc (spare)	 Adjustable Glide 4 PCS	 screw#4*5/8'' 30Pcs+1Pc (spare)	 6Hole L-Bracket 5Pcs	 80mm Black Grommet 2 PCS

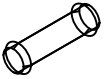
STEP1

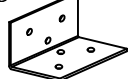
STEP2

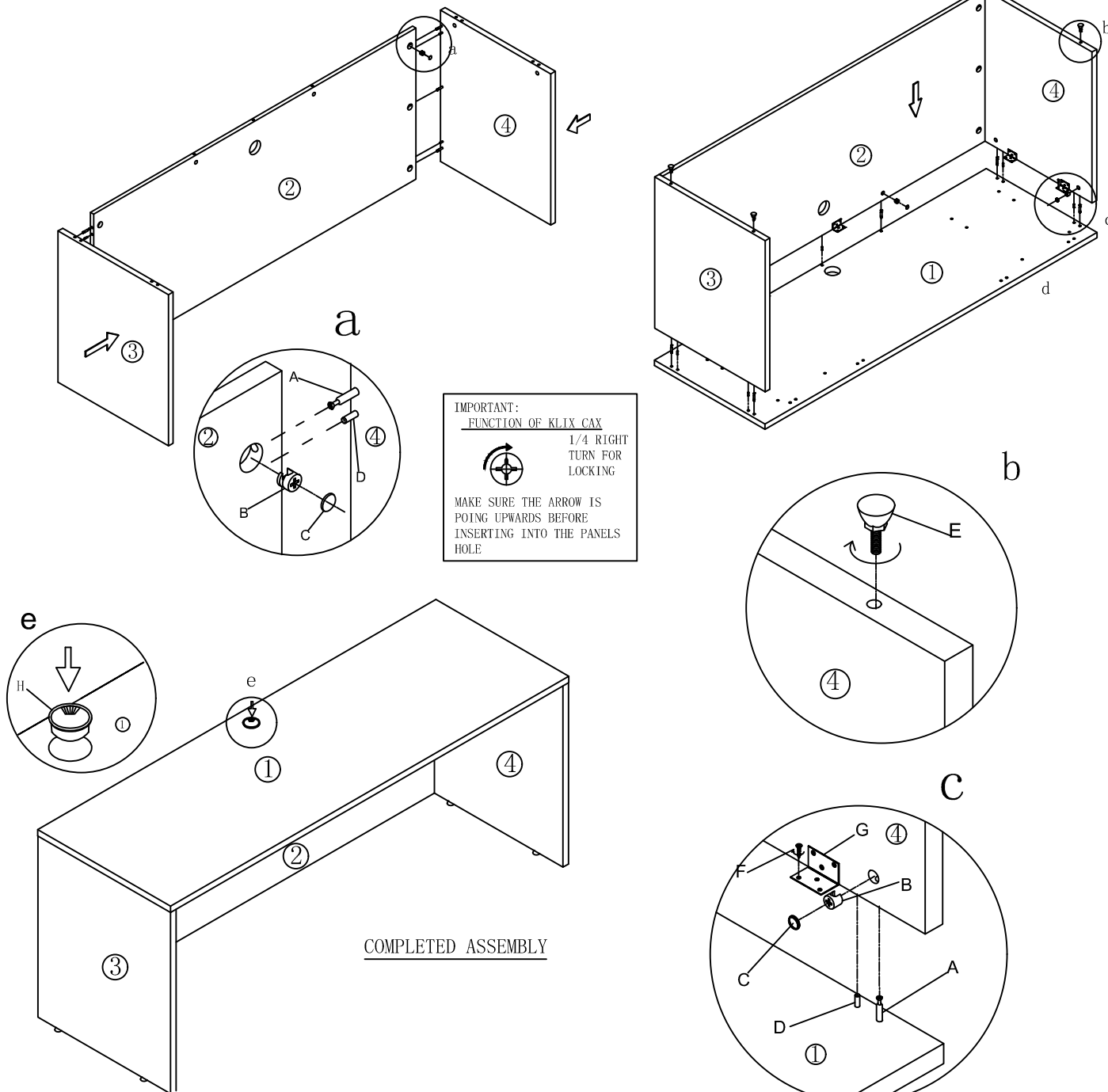

COMPLETED ASSEMBLY

IMPORTANT NOTE:

- Place all laminated parts on a clean and smooth surface such as a rug or carpet to avoid the parts from being scratched.
- Check to be sure that you have all parts and hardware.
- Remove all wrapping materials, including staples & packing straps before you start to assemble.
- Don't tighten all screws/bolts until all completely assembled.
- Keep all hardware parts out of reach of children
- If the product is not working properly, is missing a part, is damaged, or if you have any questions, please call customer service hotline before returning.
- Customer Service Hotline: 1-800-593-1888 For further assembly instructions, please visit our website at www.boschair.com